

DUBLIN TABLE 230/300x120

07/15/2022



10 min



x2

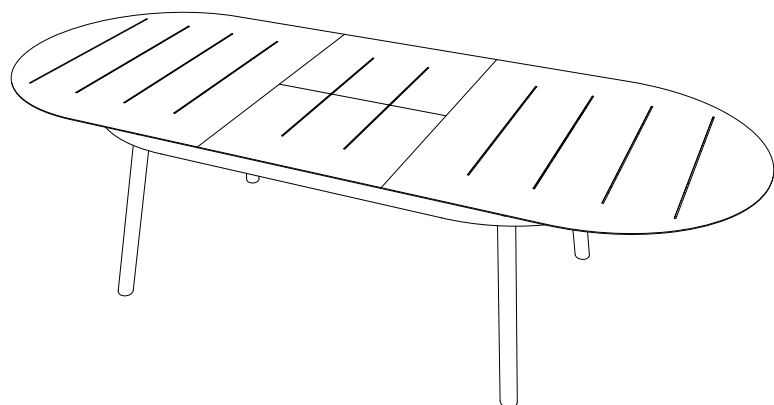

**AVANT DE COMMENCER, SE REPORTER
AUX CONSEILS DE MONTAGE EN ANNEXE**

**BEFORE STARTING, REFER TO THE
ASSEMBLING ADVICE IN ANNEX**

**VOR DER MONTAGE,
BEILIEGENDE ANWEISUNGEN
BEFOLGEN.**

**PRIMA DI COMINCIARE LEGGETE LE IS
TRUZIONI DI MONTAGGIO**

**ANTES DE COMERÇAR, ADIR-SE AOS
CONSELHOS DE MONTAGEM EM ANEXO**

**ANTES DE EMPEZAR CONSULTELOS
CONSEJOS PARA EL MONTAJE**

**PRIJE MONTIRANJA OVOG ARTIKLA,
MOLIMO PROU CITE PRILO ZENE UPUTE
ZA MONTAZU**

**BASLAMADAN ONCE,
EKTEKI MONTAJ TALIMATLARINI
INCELEYINIZ**

A x1

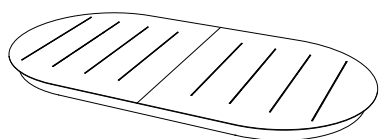

B x4

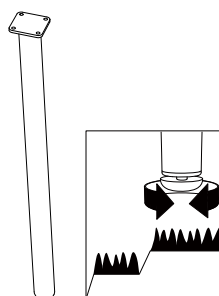

AA x8



BB x1



NOTICE DE MONTAGE
ASSEMBLING INSTRUCTIONS
MONTAGEANLEITUNG
ISTRUZIONI DI MONTAGGIO
INSTRUÇÕES DE MONTAGEM
INSTRUCCIONES DE MONTAJE
UPUTE ZA MONTAZU
MONTAJ TALIMATI

01

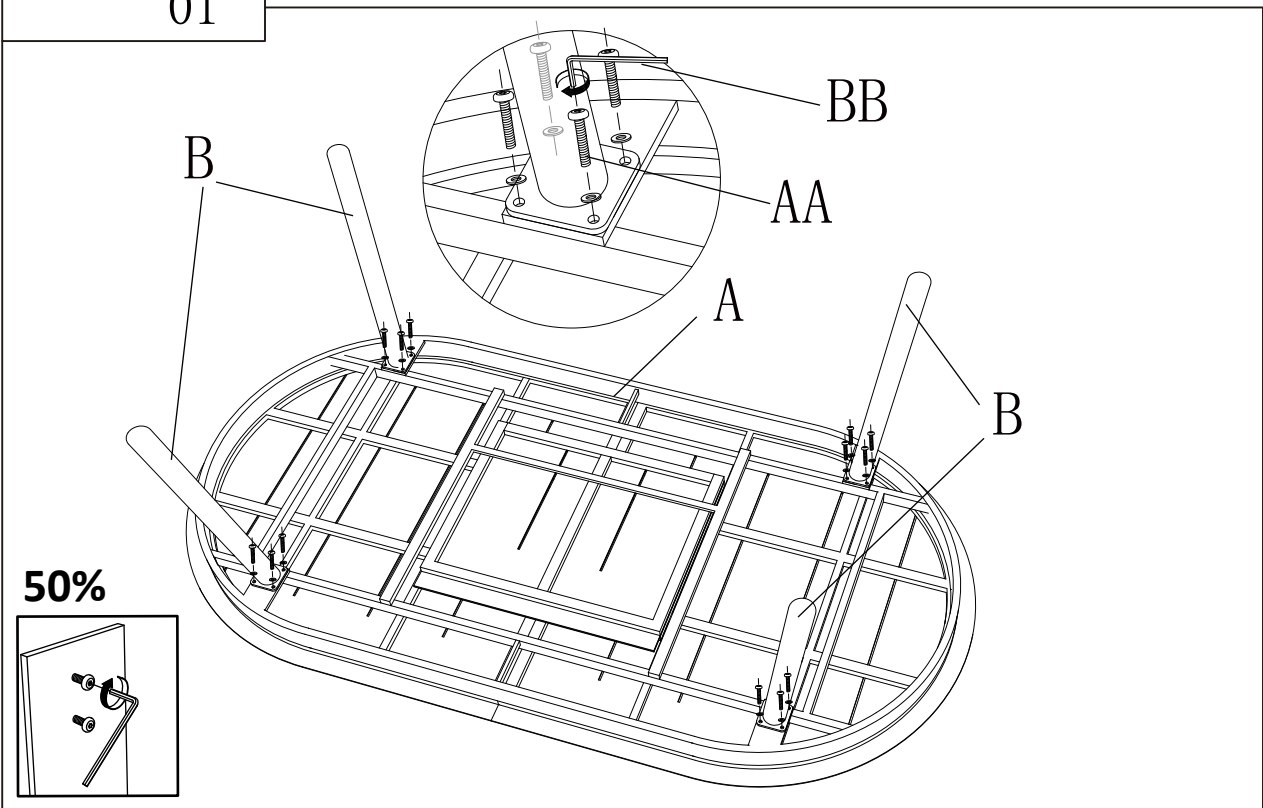

02

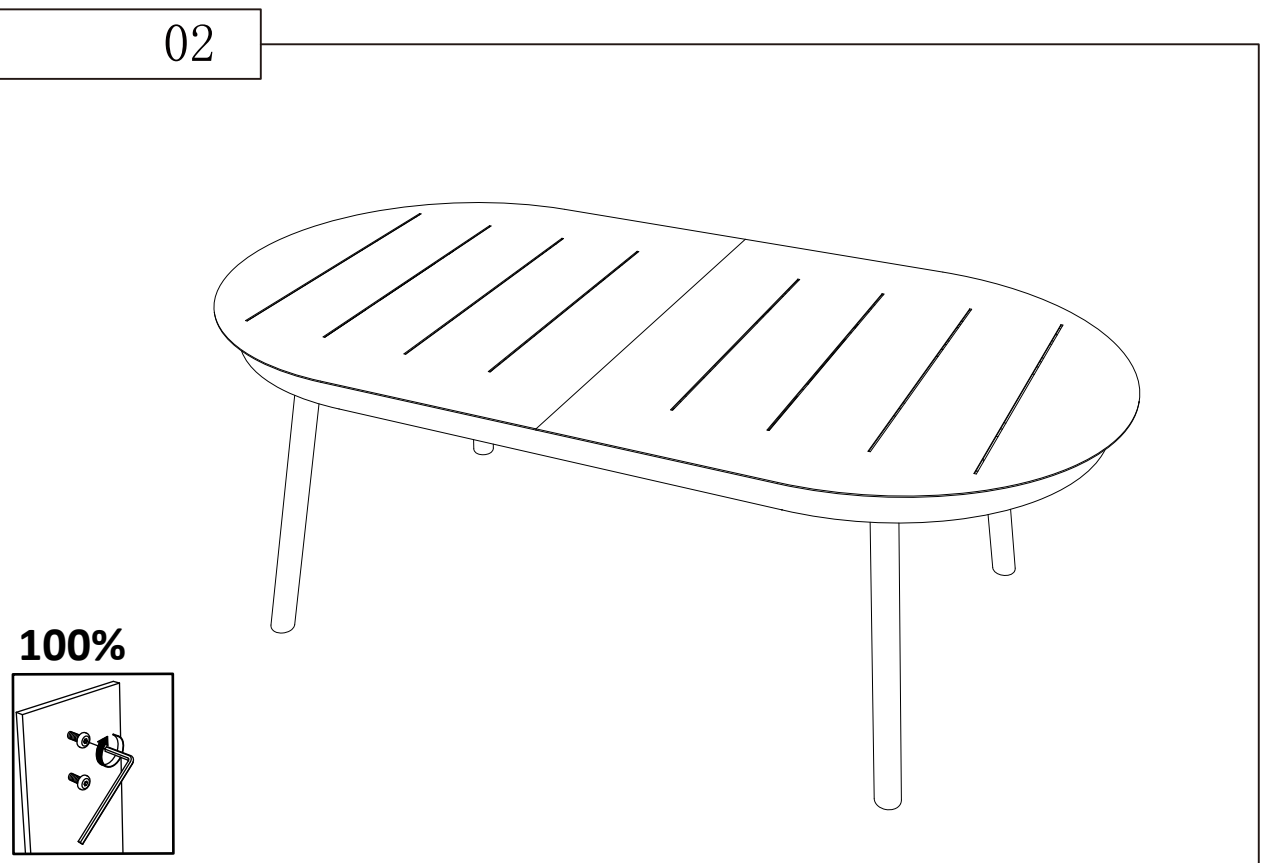

NOTICE DE MONTAGE
ASSEMBLING INSTRUCTIONS
MONTAGEANLEITUNG
ISTRUZIONI DI MONTAGGIO
INSTRUÇÕES DE MONTAGEM
INSTRUCCIONES DE MONTAJE
UPUTE ZA MONTAZU
MONTAJ TALIMATI

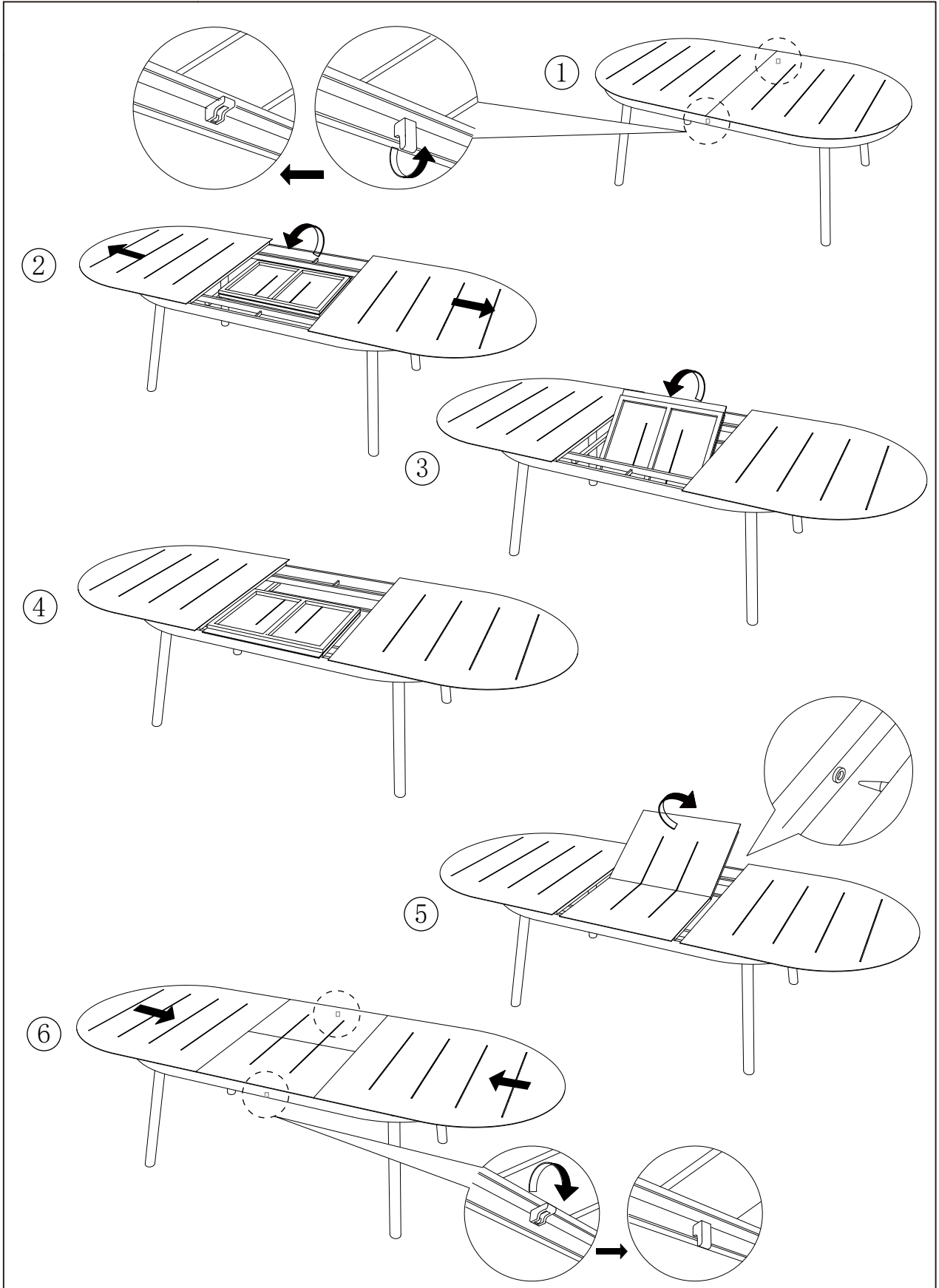

NOTICE DE MONTAGE
ASSEMBLING INSTRUCTIONS
MONTAGEANLEITUNG
ISTRUZIONI DI MONTAGGIO
INSTRUÇÕES DE MONTAGEM
INSTRUCCIONES DE MONTAJE
UPUTE ZA MONTAZU
MONTAJ TALIMATI

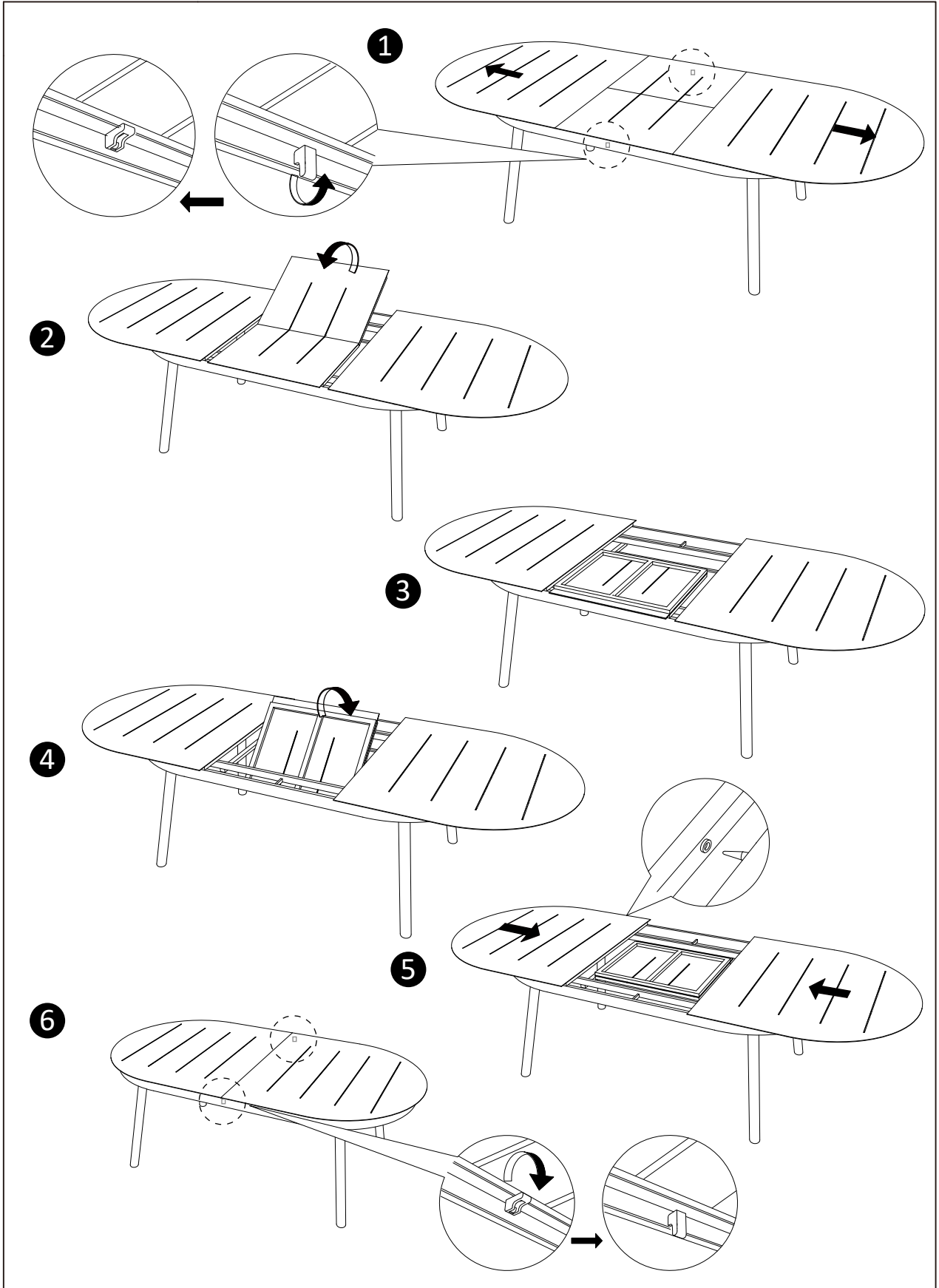

FRANÇAIS – SUISSE

CONSEILS DE MONTAGE

- 1- Bien étudier la notice de montage.
- 2 - Repérez les pièces constituant votre meuble.
- 3 - Regroupez et contrôlez la quincaillerie.
- 4 - Munissez-vous de l'outillage nécessaire .
- 5 - Aménagez-vous une zone de montage.
- 6 - Procédez au montage.



NE JAMAIS FORCER LES ASSEMBLAGES.
RESSERREZ LES VIS APRES QUELQUES TEMPS D'USAGE.
GARDER VOTRE NOTICE DE MONTAGE, SI UNE PIECE
VENAIT A MANQUER, ELLE SERAIT LE PLUS CLAIR MOYEN
DE COMMUNIQUER AVEC VOTRE MAGASIN

CONSEILS D'ENTRETIEN

- 1 - Dépoussiérez soigneusement
- 2 - Utilisez un chiffon sec



	PAPIER DECOR	SURFACES STRATIFIEES	SURFACES LAQUEES	BOIS VERNIS	TEXTILE CUIR
- NE JAMAIS UTILISER DE PRODUITS ABRASIFS: POUDRE, LAINE D'ACIER, SOLVANTS. - NE PAS MOUILLER	EAU SAVONNEUSE (SAVON NEUTRE)	○	○	○	○
	EAU ADDITIONNEE		○	○	
	ENTRETIEN SPECIFIQUE FABRICANT				○

Pour assurer les bons fonctionnement et usage des mécanismes, veuillez les huiler régulièrement avec un produit approprié.

DEUTSCH – SCHWEIZ

MONTAGE ANLEITUNG :

- 1- Die montageanleitung sorgfältig durchlesen.
- 2 - Die einzelteile des möbelstückls ermitteln.
- 3 - Die beschläge zusammenlegen und prüfen.
- 4 - Das notwendige werkzeug zurechtlegen.
- 5 - Einen montagebereich freimachen.
- 6 - Das möbelstück zusammenbauen.



NIEMALS DIE VERBINDUNGEN ZU STARK ANZIEHEN.
DIE SCHRAUBEN NACH EINIGER ZEIT DES GEBRAUCHS
ERNEUT FESTZIEHEN. DIE MONTAGEANLEITUNG GUT AUFBEWAHREN:
SOLLTE EIN TEIL FEHLEN, IST SIE DAS BESTE
VERSTÄNDIGUNGSMITTEL MIT IHREM GESCHÄFT.

PFLEGEHINWEISE :

- 1 - Sorgfältig entstauben.
- 2 - Verwenden sie ein trockenes tuch.



	DEKORPAPIER	OBERFLÄCHE LAMINAT	OBERFLÄCHE LACK	LACKIERTEM HOLZ	TEXTIL LEDER
- BENUTZEN SIE KEINE SCHEUERMITTEL WIE PULVER, STAHLWOLLE, LÖSUNGSMITTEL. - KEIN WASSER VERWENDEN	SEIFENLAUGE (NEUTRALSEIFE)	○	○	○	○
	WASSER MIT HAUSHALTSREINIGER		○	○	
	PRODUZENT SPECIFISCHER UNTERHALT				○

ITALIANO - SUISSE

CONSIGLI DI MONTAGGIO

- 1- Studiare bene le istruzioni di montaggio.
- 2 - Prendere conoscenza dei pezzi che costituiscono il mobile.
- 3 - Raggruppare e controllare la ferramenta.
- 4 - Munirsi degli utensili necessari.
- 5 - Preparare una zona di montaggio.
- 6 - Procedere al montaggio.



NON FORZARE MAI GLI ASSEMBLAGGI RISTRINGERE LE VITI
DOPO UN PERIODO D'USO CONSERVARE QUESTE
ISTRUZIONI DI MONTAGGIO, SE UN PEZZO VENISSE
A MANCARE SAREBBE IL MIGLIORE MEZZO
DI COMUNICAZIONE CON IL RIVENDITORE

CONSIGLI PER LA MANUTENZIONE

- 1 - Spolverate accuratamente
- 2 - Usare un panno asciutto



	CARTA	SUPERACIE STRATIFICATE	SUPERFICIE LACCATE	LACCATE EGNO VERNICIATO	TESSILE CUIRO
- NON UTILIZZARE MAI PRODOTTI ABRASIVI: POLVERE, LANA DI ACCIAIO, SOLVENTI. - NON BAGNARE	ACQUA CON SAPONE (SAPONE NEUTRO)	○	○	○	○
	ACQUA CON DETERGIVO SAN MARC		○	○	
	MANUTENZIONE SPECIFICA PRODUTTORE				○



PORTUGUES

CONSELHOS DE MONTAGEM:

- 1- Estude bem as instruções de montagem.
- 2 - Reuna as peças que constituem o seu móvel.
- 3 - Reagrupe as ferragens.
- 4 - Equipe-se com as ferramentas necessárias.
- 5 - Prepare uma área para a montagem.
- 6 - Inicie a montagem.



NUNCA FORÇAR OS ENCAIXES.
REAPERTAR OS PARAFUSOS APÓS UN TEMPO DE UTILIZAÇÃO.
GUARDAR AS INSTRUÇÕES DE MONTAGEM.
CASO FALTE ALGUMA PEÇA, O MAIS ACONSELHÁVEL
É CONTATAR O REVENDEDOR.

CONSELHOS PARA A MANUTENÇÃO:

- 1 - Eliminar bem o pó
- 2 - Usar pano seco



	ACABAMENTO IMITAÇÃO	SUPERFÍCIES ESTRATIFICADAS	SUPERFÍCIES LACADAS	MADERA ENVERNIZADA	TEXTÉIS PELES
- NUNCA UTILIZAR PRODUTOS ABRASIVOS : SAPONÁCEOS, LÃ DE AÇO, SOLVENTES. - NÃO MOLHAR	AGUA COM SABÃO (SABÃO NEUTRO)	○	○	○	○
	AGUA COM DETERGENTE		○	○	
	INSTRUÇÕES ESPECÍFICAS DO FABRICANTE				○

ESPAÑOL

CONSEJOS PARA EL MONTAJE:

- 1- Estudie atentamente el manual de montaje.
- 2 - Localice las piezas que constituyen su mueble.
- 3 - Reuna y contróle los tornillos.
- 4 - Equipe-se de las herramientas necesarias.
- 5 - Prepare una zona de montaje.
- 6 - Realice el montaje.



NO FUERCE NUNCA EN LAS UNIONES .
APRIETE LOS TORNILLOS DESPUES DE CIERTO TIEMPO DE UTILIZACION
CONSERVE SU MANUAL DE MONTAJE,
SI FALTARA UNA PIEZA, SERIA LA MANERA MAS FACIL DE COMUNICAR
CON LA TIENDA

CONSEJOS PARA EL MANTENIMIENTO:

- 1 - Despolvorear cuidadosamente
- 2 - Utilice un paño seco



	PAPEL DE DECORACION	SUPERFICIE ESTRATIFICADAS	SUPERFICIE MAQUEADAS	MADERA BARNIZADA	TEXTIL/ CUERO
- NO USE NUNCA PRODUCTOS ABRASIVOS TALES COMO: POLVO DE LIMPIAR, LANA DE ACERO, SOLVENTES.	AGUA Y JABON (JABON NEUTRO)	○	○	○	○
	AGUA COM DETERGENTE		○	○	
	MANTENIMIENTO ESPECIFICO DEL FABRICANTE				○

HRVATSKA

UPUTE ZA MONTAŽU:

- 1- Pažljivo procitajte upute za montažu.
- 2 - Pripremite sve dijelove namještaja.
- 3 - Prikupite i provjerite okove za montažu.
- 4 - Pripremite potreban alat.
- 5 - Pripremite prostor za montažu.
- 6 - Pognite montirati.



NEMOJTE UPOTREBLJAVATI SILU PRILIKOM SKLAPANJA NAKON
NEKOG VREMENA PONOVRNO PRITEGNITE VIJKE CUVAJTE UPUTE
ZA MONTAŽU U SLUCAJU NEDOSTATKA NEKOG DIJELA NAJBOLJE
CE BITI DA DA KONTAKIRATE PRODAJNO MJESTO

UPUTE ZA ODRŽAVANJE:

- 1 - Pažljivo obrisati prašinu
- 2 - Koristite suhu krpu



	PAPIR	LAMINAT	LAK	DRVO	TEKSTIL/ KOZU
- ZABRANJENA JE UPOTREBA KEMIČALIJA ILI BILO KAKVIH POMOCNIH SREDSTAVA ZA RIBANJE JAKIH SREDSTAV ZA ČIŠĆENJE ILI CELICNE VUNE.	OPTINA SAPUNA	○	○	○	○
	OPTINA DETEROZENTA		○	○	
	NAMIENSKA SREDSTVA				○



TÜRKÇE

MONTAJ TALIMATLARI:

- 1- Montaj tanıtım yazısını dikkatlice okuyunuz.
- 2 - Mobilyanızı oluşturan parçaları isaretleiniz.
- 3 - Hirdavatla ilgili parçaları bir araya toplayıp: kontrol ediniz.
- 4 - Gereken araç ve gereci tedarik ediniz.
- 5 - (Kendinize) Bir montaj alanı ediniz.
- 6 - Monte etmeye başlayınız.



MONTAJLARI ZORLAMAYINIZ.
BIRKAC KULLANIMDAN SONRA VIDALARI SIKISTIRINIZ.
BIR PARCANIN KAYBOLMASI DURUMUNDA MAGAZANIZLADAKI
KOLAY ILETISIME GECEBILMENIZ ICIN MONTAJ KULLANIM
TALIMATINIZI SAKLAYINIZ.

BAKIM TALIMATLARI:

- 1 - Tozunu dikkatlice alınız
- 2 - Yumusak bir bezi temiz si ve az miktarda sabunla(deterjan) nemlendiriniz



- ASLA ASINDIRICI ÜRÜNLER KULLANMAYINIZ:
CELİK YÜNÜ, SOLVENT...
- BOL SUYLA YIKAMAYINIZ

SABUNLU SU
(NÖTR SABUN)
DETERJAN KATILMIS SU
ÜRETİCİYE ÖZGÜ BAKIM

SÜS KAGIDI	KATMAN YÜZEY	LAKE YÜZEY	ÇİHALI TAHTA	TEKSTİL DERİ
○	○	○	○	○
	○	○		
				○

ENGLISH

ASSEMBLY ADVICE:

- 1- Carefully read the assembly instruction.
- 2 - Identify the components of the furniture.
- 3 - Group and check the hardware.
- 4 - Use the required tools.
- 5 - Create an assembly zone.
- 6 - Make the assembly.



NEVER FORCE THE CONNECTIONS.
RE-TIGHTEN THE SCREWS AFTER FEW DAYS.
PLEASE RETAIN THE AI LEAFLET FOR FUTURE REFERENCE, THE AI
CONTAINS INFORMATION WHEN CLAIMING FOR MISSING PARTS.

CLEANING ADVICE:

- 1 - Carefully remove the dust
- 2 - Use a soft, clean damp cloth with soapy water



- NEVER USE ABRASIVE PRODUCTS OR SOLVENTS.
DO NOT APPLY EXCESSIVE PRESSURE WHEN
USING THE DAMP CLOTH.

SOAPY WATER
(NEUTRAL SOAP)
WATER WITH DETERGENT
SPECIFIC SUPPLIER
CLEANING

PAPER DECOR	LAMINATED SURFACES	LACQUERED SURFACE	VARNISHED WOOD	LEATHER TEXTILE
○	○	○	○	○
	○	○		
				○

To ensure proper functioning and use of any mechanism, please do clean first then apply regularly adapted oil.

БЪЛГАРСКИ

СЪВЕТИ ЗА МОНТАЖ

- 1- ВНИМАТЕЛНО ПРОЧЕТЕТЕ ИНСТРУКЦИЯТА
- 2 - ЗАПОЗНАЙТЕ СЕ С ЧАСТИТЕ ЗА МОНТАЖ
- 3 - ПРОВЕРЕТЕ И ГРУПИРАЙТЕ КРЕПЕЖНИТЕ ЕЛЕМЕНТИ
- 4 - ИЗПОЛЗВАНЕТО НА ДОПЪЛНИТЕЛНИ ИНСТРУМЕНТИ Е НЕОБХОДИМО
- 5 - ОРГАНИЗИРАЙТЕ ЗОНАТА ЗА МОНТАЖ
- 6 - ИЗВЪРШЕТЕ МОНТАЖА



ПРИЛАГАЙТЕ СИЛА ПРИ МОНТАЖА.
ЗАТЕГНЕТЕ КРЕПЕЖНИТЕ ЕЛЕМЕНТИ СЛЕД
ИЗВЕСТНО ВРЕМЕ

СЪВЕТИ ЗА ПОДДРЪЖКА :

- 1 - ПОЧИСТЕТЕ ОТ ПРАХ
- 2 - ИЗПОЛЗВАЙТЕ СУХА КЪРПА



НЕ ИЗПОЛЗВАЙТЕ АБРАЗИВНИ
ПРОДУКТИ ЗА ПОЧИСТВАНЕ

САПУНЕНА ВОДА
ЧИСТА ВОДА
СПЕЦИФИЧНО ПОЧИСТВАНЕ

ДЕКОР ХАРТ	ЛАМИНИРАНА ПОВЪРХНОСТ	ЛАКИРАНА ПОВЪРХНОСТ	ЛАКИРАНО ДЪРВО	ТЕКСТИЛ
○	○	○	○	○
	○	○		
				○

Attention aux risques de cisaillement et de pincement en cours d'utilisation / Watch out to hazard of cutting or squeezing when assembling and using Conforme aux exigences de sécurité / complies with EC safety requirements

